

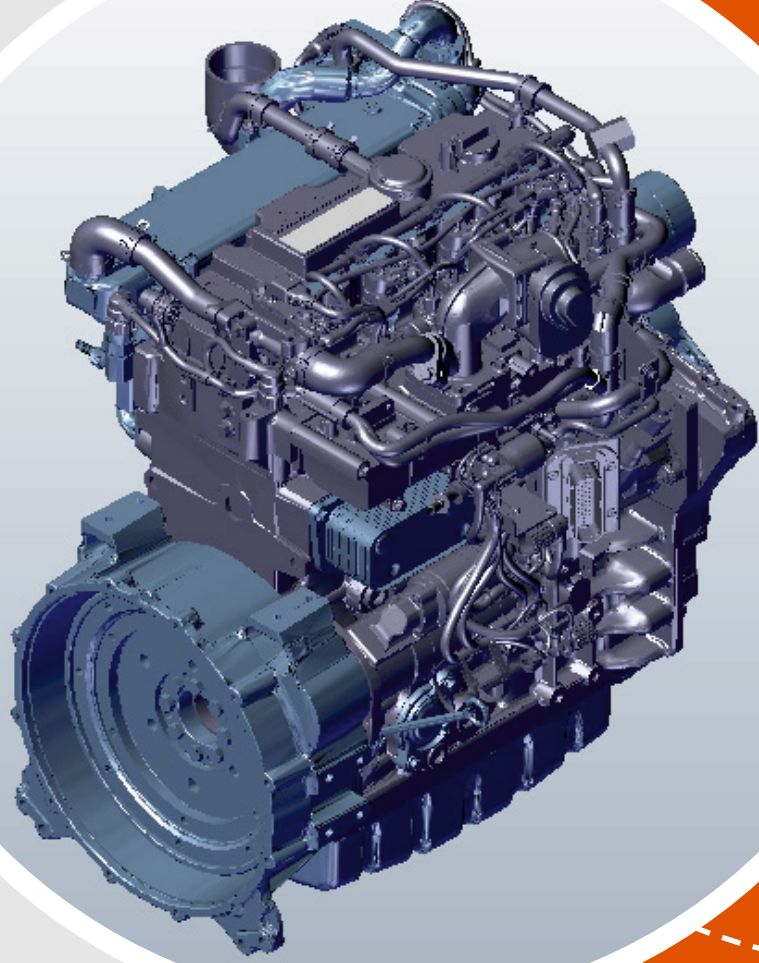

KARER



DİZEL MOTOR ÇÖZÜMLERİ
ENGINE SOLUTIONS

www.karer.tr

HAKKIMIZDA

KARER, yeraltı maden makineleri üretimi ve KARADAVUT MAKİNA'nın satış sonrası garantisi ile dizel motor çözümleri sağlayan bir şirkettir. Yeraltı madencilik uygulamalarındaki zorlu koşullara yönelik şirketimizin tecrübeli kadrosu ile dizel motor ve parçaları konusunda müşterilerimize en uygun seçenekleri sunmaktayız.

Ana ürünlerimiz iki ana türe ayrılmaktadır. Bunlar; hava soğutmalı motorlar ve su soğutmalı motorlardır.

Hava soğutmalı dizel motor modelleri arasında 912 / 914 / 413F / 513 / 1011 / 2011 vb. bulunur.

Su soğutmalı dizel motorlarımız arasında 1012 / 1013 / 2012 / 2013 / 1015 / 2015 ve ayrıca Deutz'un 2.2 / 2.9 / 3.6 / 4.1 / 6.1 / 7.8 / 12.0 / 16.0 gibi en son modelleri bulunur. Müşterilerimize, ihtiyaçlarına yönelik, daha uygun maliyetli, rekabetçi fiyatlarla ve servis garantisi ile alternatif motor seçenekleri de sunmaktayız.

Amacımız, doğru ürün, doğru fiyat ve satış sonrası kaliteli hizmet ile sürekli müşteri memnuniyetini sağlamaktır.



ABOUT US

KARER is a company that manufactures underground mining machines and provides diesel engine solutions with KARADAVUT MAKİNA's after-sales guarantee. With our company's experienced staff for the difficult conditions in underground mining applications, we offer our customers the most suitable options in diesel engines and parts.

Our main products are divided into two main types. These are; air-cooled engines and water-cooled engines.

Air-cooled diesel engine models include 912 / 914 / 413F / 513 / 1011 / 2011 etc.

Our water-cooled diesel engines include the latest models such as 1012 / 1013 / 2012 / 2013 / 1015 / 2015 and also Deutz's 2.2 / 2.9 / 3.6 / 4.1 / 6.1 / 7.8 / 12.0 / 16.0. We also offer our customers alternative engine options that are more cost-effective, competitively priced and with service guarantee.

Our aim is to ensure continuous customer satisfaction with the right product, the right price and quality after-sales service.

◆ DIZEL MOTOR ENGINE



413



912



914



1011_1012



1013



1015



2012



2013



2015



F12L513



TCD2.9

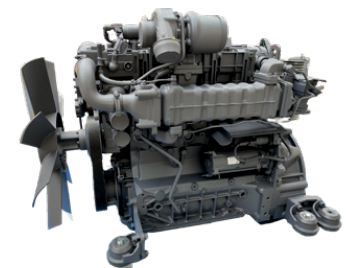

TCD4.1



TCD6.1



TCD 12.0 L6



TCD 16.0 V8

◆ **MERMER SONDAJ MAKINALARI** MARBLE DRILLING MACHINES



MERMER SONDAJ MAKİNALARINA YÖNELİK EN ÇOK TERCİH EDİLEN DİZEL MOTOR MODELLERİMİZ

OUR MOST PREFERRED DIESEL ENGINE MODELS FOR MARBLE DRILLING MACHINES

1.F4L912

Motor Modeli Engine Model	F4L912
Marka Brand	Beinei (DEUTZ Alternatif) Beinei (DEUTZ Alternative)
Silindir Sayısı ve Düzenlemesi Number and Arrangement of Cylinders	Sıralı 4 Silindirli In-line 4 Cylinder
Hava Alım Şekli Air Intake Type	Doğal Natural
Soğutma Sistemi Cooling System	Hava Soğutmalı Air Cooled
Deplasman (L) Displacement (L)	3,77
Çap / Strok Bore / Stroke	100 / 120
Sıkıştırma Oranı Compression Ratio	17 : 1
Maksimum Devirde (2500 rpm) Güç Power at Maximum Speed (2500 rpm)	51 kW (70 Hp)
Maksimum Tork (Nm) Maximum Torque (Nm)	230
Maksimum Tork Devri (rpm) Maximum Torque Speed (rpm)	1.600
Minimum Rölanti Hızı (rpm) Minimum Idle Speed (rpm)	700
Yakıt Tüketimi (g/kWh) Fuel Consumption (g/kWh)	221
Ağırlık (kg) Weight (kg)	300
Sertifikalar Certificates	CE
	ISO 9001 Quality Assured Firm
	ISO 14001 Environment Assured Firm



2. F2L912

Motor Modeli Engine Model	F2L912
Marka Brand	Beinei (DEUTZ Alternatif) Beinei (DEUTZ Alternative)
Silindir Sayısı ve Düzenlemesi Number and Arrangement of Cylinders	Sıralı 2 Silindirli In-line 2 Cylinder
Hava Alım Şekli Air Intake Type	Doğal Natural
Soğutma Sistemi Cooling System	Hava Soğutmalı Air Cooled
Deplasman (L) Displacement (L)	1,88
Çap / Strok Bore / Stroke	100 / 120
Sıkıştırma Oranı Compression Ratio	17 : 1
Maksimum Devirde (2300 rpm) Güç Power at Maximum Speed (2300 rpm)	20 kW (27 Hp)
Maksimum Tork (Nm) Maximum Torque (Nm)	105
Maksimum Tork Devri (rpm) Maximum Torque Speed (rpm)	1.600
Minimum Rölanti Hızı (rpm) Minimum Idle Speed (rpm)	700
Yakıt Tüketimi (g/kWh) Fuel Consumption (g/kWh)	230
Ağırlık (kg) Weight (kg)	245
Sertifikalar Certificates	CE
	ISO 9001 Quality Assured Firm
	ISO 14001 Environment Assured Firm

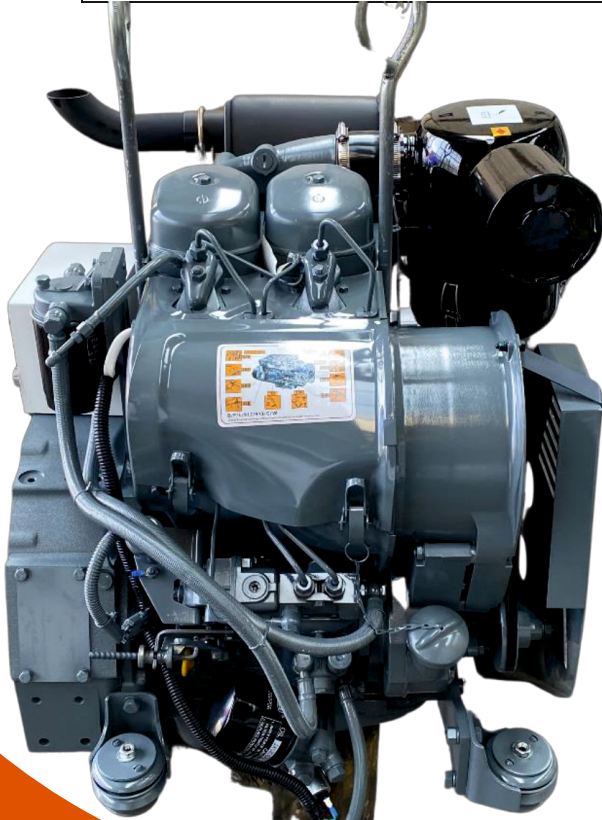

◆ YEDEK PARÇALAR SPARE PARTS 912/914/413/513



YAĞ FİLTRESİ
OIL FILTER



YAKIT FİLTRESİ
FUEL FILTER



HAVA FİLTRESİ
AIR FILTER



ŞARJ DİNAMOSU
GENERATOR



PİSTON
PISTON



PİSTON
PISTON



YAĞ POMPASI
LUBRICAT.OIL PUMP



KENAR YATAK/ANA YATAK
THRUST WASHER/MAIN BEARING



PİSTON SEGMANI TAKIM
SET OF PIST. RINGS



ENJEKTÖR
INJECTOR



EMME SUBABI/SUBAB GAYDI
INLET VALVE/VALVE GUIDE

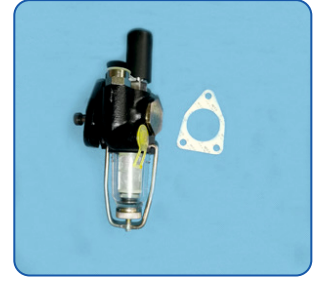

YAKIT BESLEME POMPASI
FUEL SUPPLY PUMP



STOP SOLENOİDİ
SOLENOID



İKİLİ YAKIT FİLTRESİ
TWO-ST.FUEL FILTER



BİYEL KOLU
CONNECTING ROD



GÖMLEK
CYLINDER



TURBO
TURBOCHARGER

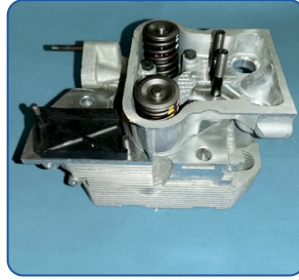

SİLİNDİR KAPAK
CYLINDER HEAD



YÜKSEK BASINÇ POMPASI
HIGH-PRESSURE PUMP



TAKIM CONTA
GASKET SET

YEDEK PARÇALAR SPARE PARTS 1011/2011 ◆



YAKIT FİLTRESİ
FUEL FILTER



YAĞ FİLTRESİ
OIL FILTER



MARŞ DİNAMOSU
STARTER

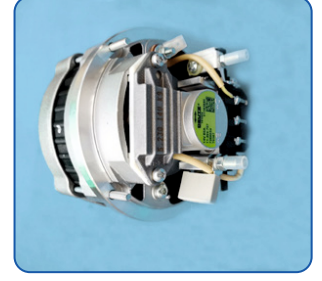

ŞARJ DİNAMOSU
GENERATOR



ENJEKTÖR
INJECTER



STOP SOLENOİDİ
SOLENOID

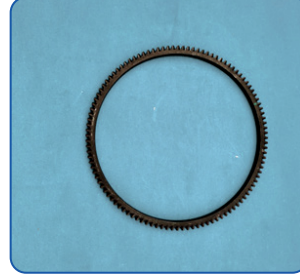

VOLAN DIŞLİSİ
GEAR RIM



KAYIŞ GERGİSİ
BELT TENSIONER



MOTOR V KAYIŞI
NARROW V-BELT



TRİGER SETİ
SYNCHRO.BELT DRIVE



YAKIT ENJEKTÖR POMPASI
FUEL INJECT.PUMP

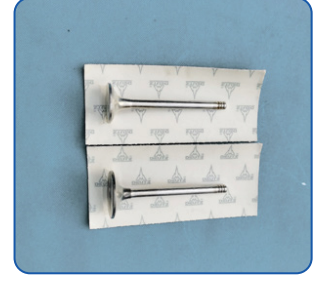

EMME SUBABI
INLET VALVE

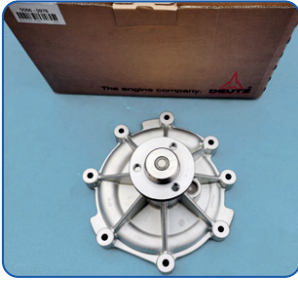

DEVİRDİİM POMPASI
COOLANT PUMP



YAĞ POMPASI
LUBRICAT. OIL PUMP



YAKIT TRANSFER POMPASI
FUEL SUPPLY PUMP



KENAR YATAK/ANA YATAK
THRUST WASHER/MAIN BEARING



PİSTON
PISTON



BİYEL KOLU
CONNECTING ROD



KRANK MİLİ
CRANKCASE



TAKIM CONTA
GASKET SET

◆ YEDEK PARÇALAR SPARE PARTS 1015/2015



YAĞ FİLTRESİ
OIL FILTER



YAKIT FİLTRESİ
FUEL FILTER



MARŞ DİNAMOSU
STARTER



ŞARJ DİNAMOSU
GENERATOR



PİSTON
PISTON



GÖMLEK
CYLINDER



KENAR YATAK/ANA YATAK
THRUST WASHER/MAIN BEARING



EMME SUBABI
INLET VALVE



MOTOR TESİSATI
CABLE HARNESS



YAĞLAMA JETİ
NOZZLE



TAZYİK SUBABI
RELIEF VALVE



STOP SOLENOİDİ
SOLENOID



DEVİRDİM POMPASI
COOLANT PUMP



EKSANTRİK MİLİ
CAMSHAFT



BİYEL KOLU
CONNECTING ROD



YAĞ POMPASI
LUBRICAT. OIL PUMP



SİLİNDİR KAPAK
CYLINDER HEAD

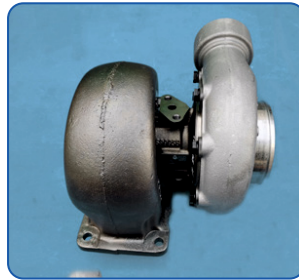

TURBO
TURBOCHARGER



KRANK MİLİ
CRANKCASE



KRANK MİLİ
CRANKSHAFT

YEDEK PARÇALAR SPARE PARTS 2.9/3.6 ◆



SEPAR FİLTRESİ
FUEL PREFILTER



YAĞ FİLTRESİ
OIL FILTER



YAKIT FİLTRESİ
FUEL FILTER



ŞARJ DİNAMOSU
GENERATOR



PİSTON
PISTON



KENAR YATAK
THRUST WASHER

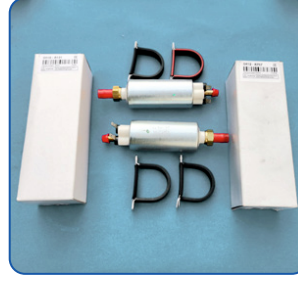

YAKIT TRANSFER POMPASI
FUEL SUPPLY PUMP



ENJEKTÖR
INJECTOR

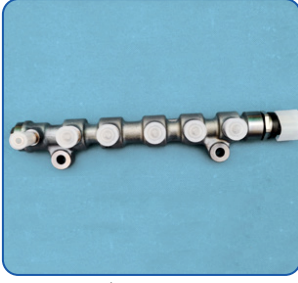

RAİL BORUSU
HIGH-PRESSURE RAIL CAVITY

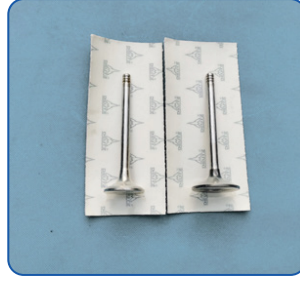

EMME SUBABI
INLET VALVE



PİSTON SEGMAN TAKIM
SET OF PIST. RINGS



YAĞ SOĞUTUCU
OIL COOLER

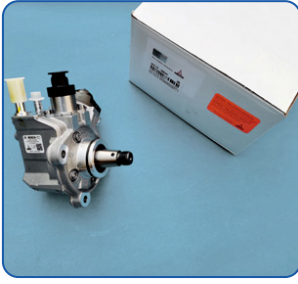

YÜKSEK BASINÇ POMPASI
HIGH-PRESSURE PUMP

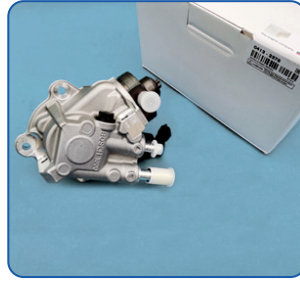

YÜKSEK BASINÇ POMPASI
HIGH-PRESSURE PUMP



YAĞ POMPASI
LUBRICAT. OIL PUMP



KAYIŞ GERGİSİ
BELT TENSIONER

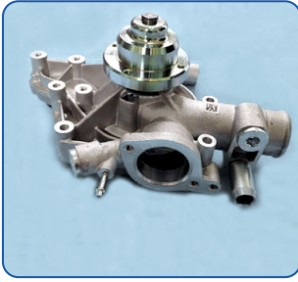

DEVİRDAİM POMPASI
COOLANT PUMP



MARŞ DİNAMOSU
STARTER



SİLİNDİR KAPAK
CYLINDER HEAD

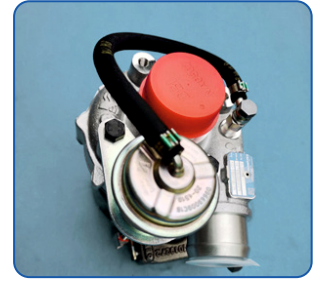

TURBO
TURBOCHARGER

◆ YEDEK PARÇALAR SPARE PARTS 1013/2012(D6E)/2013(D7E)



YAKIT FİLTRESİ
FUEL FILTER



YAĞ FİLTRESİ
OIL FILTER



YAĞ FİLTRESİ
OIL FILTER



SEPAR FİLTRE TAKIMI
FUEL PREFILTER



MARŞ DİNAMOSU
STARTER



ŞARJ DİNAMOSU
GENERATOR

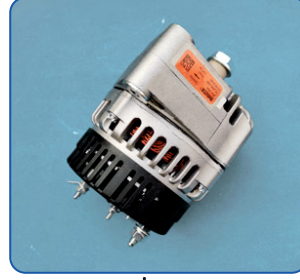

ŞARJ DİNAMOSU
GENERATOR



YAĞ SOĞUTUCU
OIL COOLER



ENJEKTÖR
INJECTOR



YAKIT ENJEKTÖR POMPASI
FUEL INJECT. PUMP



YAKIT ENJEKTÖR POMPASI
FUEL INJECT. PUMP



PİSTON SEGMANI TAKIM
SET OF PIST. RINGS



PİSTON SEGMANI GÖMLEK KİTİ
CYLINDER & PISTON



KENAR YATAK/ANA YATAK
THRUST WASHER/MAIN BEARING

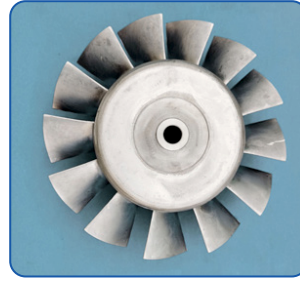

FAN
FAN



BEYİN
CONTROL UNIT



BİYEL KOLU
CONNECTING ROD



SİLİNDİR KAPAK
CYLINDER HEAD



BLOK
CRANKCASE



CONTA TAKIM
GASKET SET



KARER



KARER KARADAVUT ERDEM MAKİNA ENERJİ SANAYİ VE TİCARET LİMİTED ŞİRKETİ

+90 553 531 77 50 satis@karer.tr

Ostim OSB Mh. 1235. Cd. No:81 Yenimahalle / ANKARA

www.karer.tr